

Lillian 34 4X3 TP

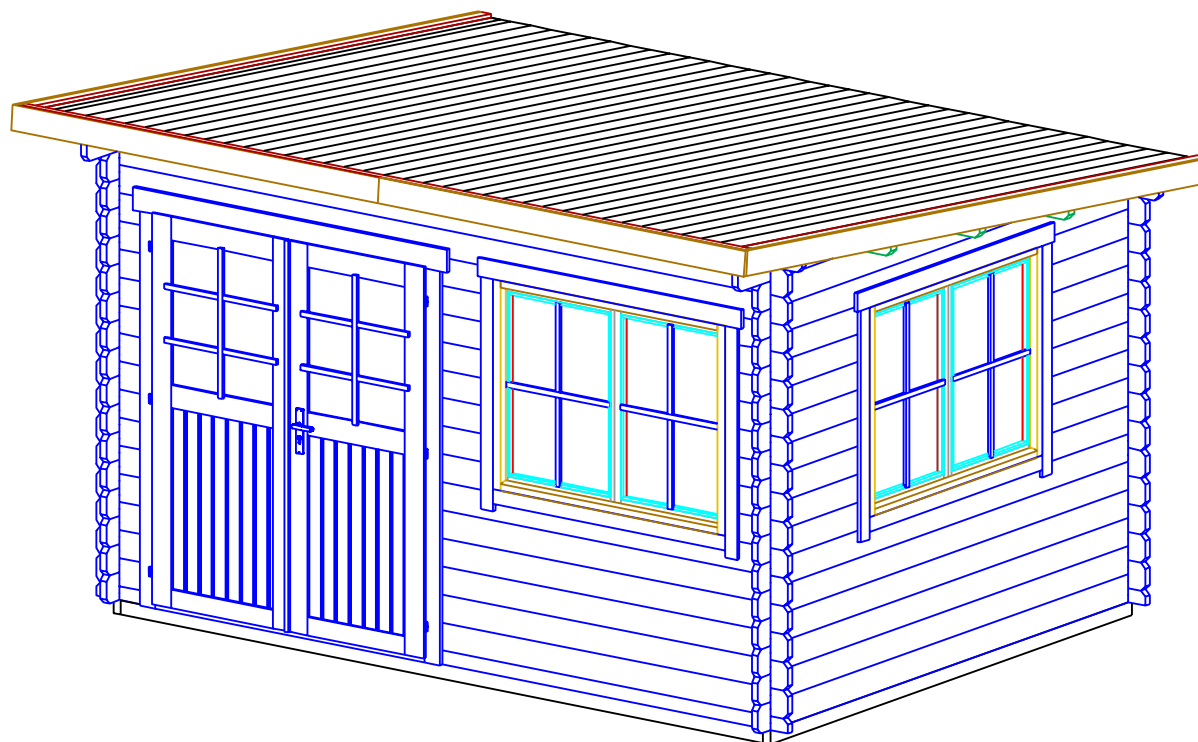

Lillian 34 4X3 TP

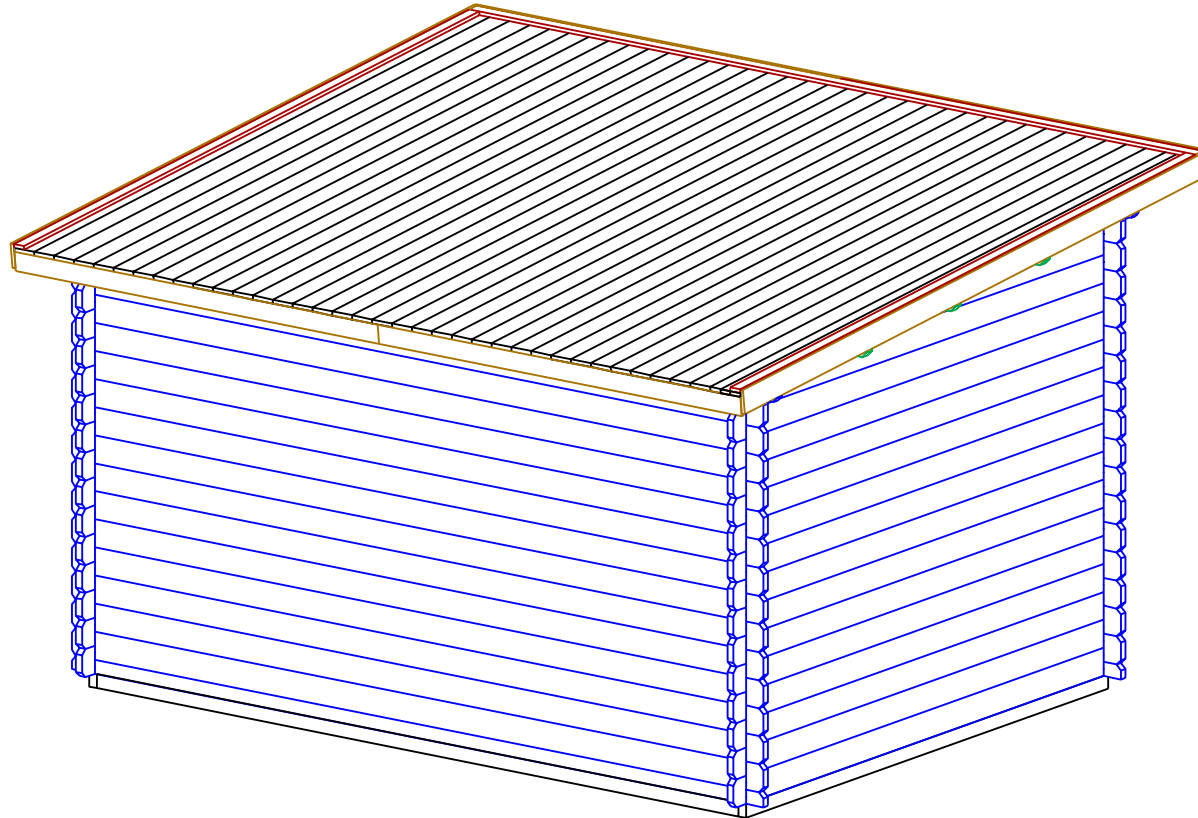

STAGE 1

Lillian 34 4X3 TP

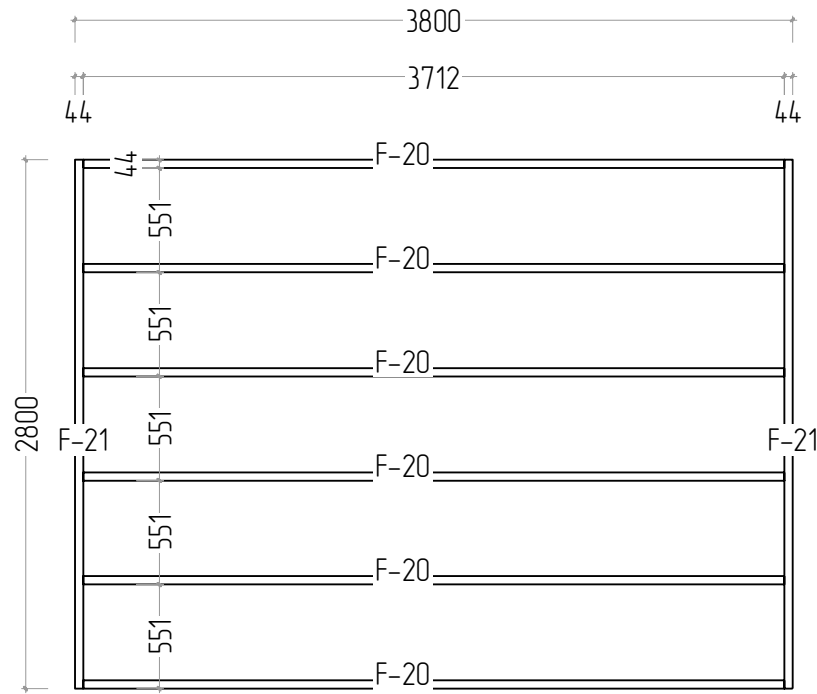

STAGE 2

Lillian 34 4X3 TP

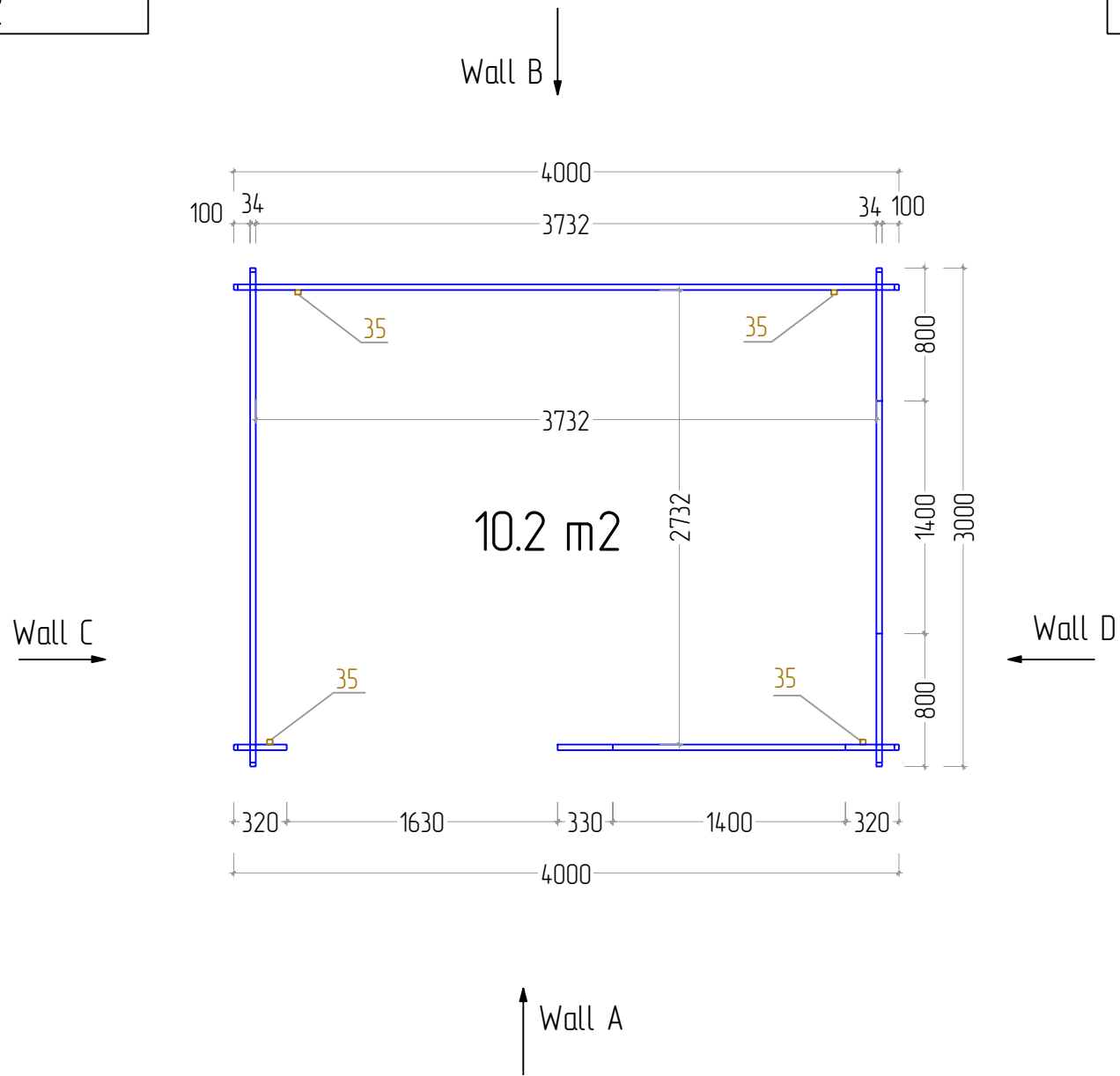

STAGE 2

Lillian 34 4X3 TP

W-A

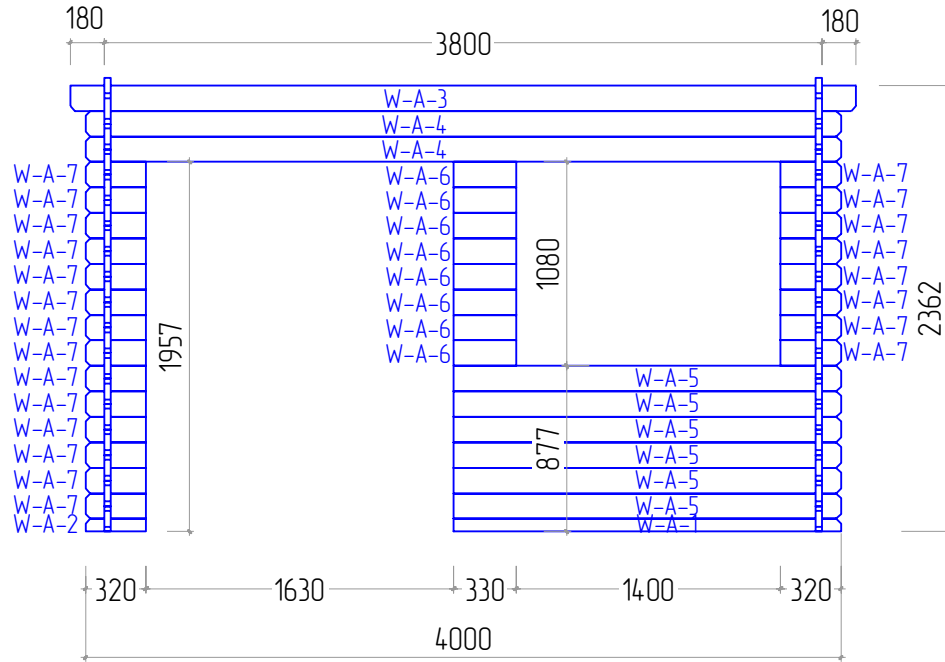

W-B

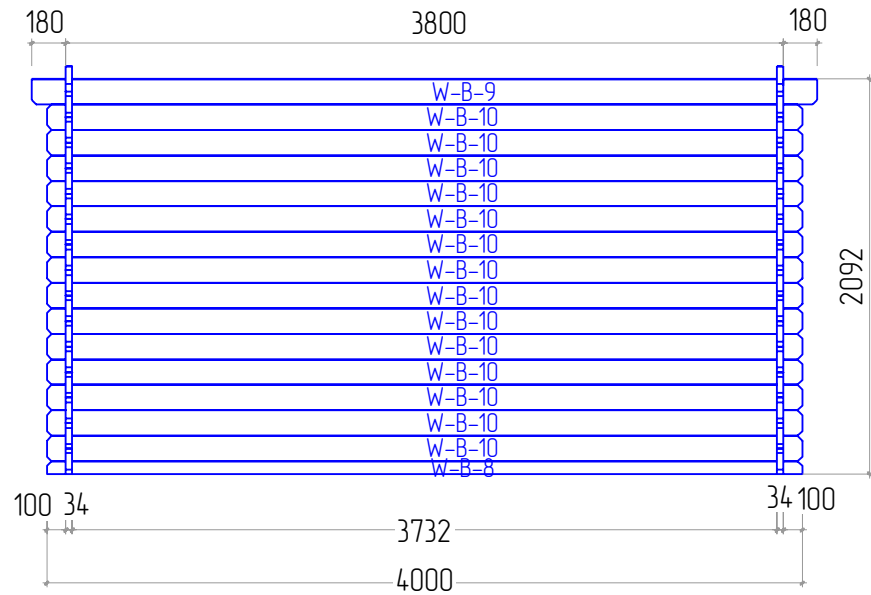

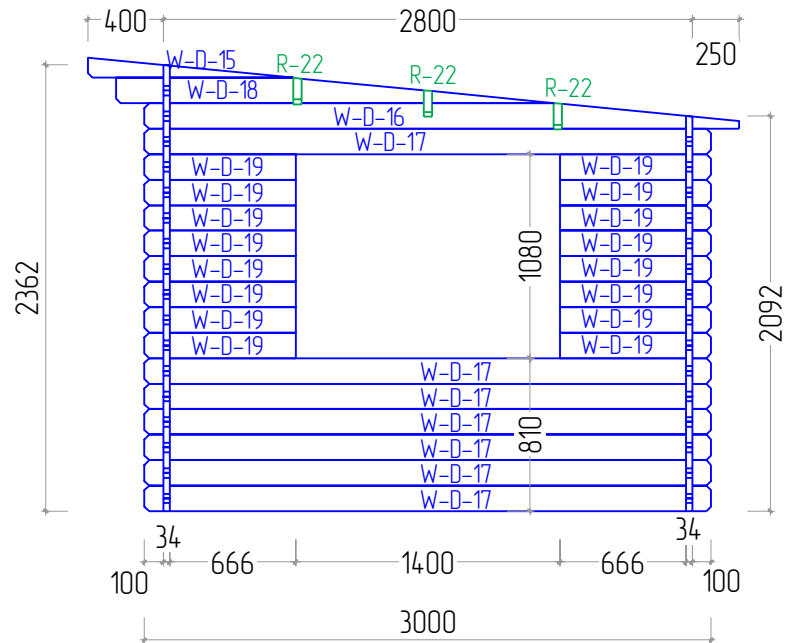
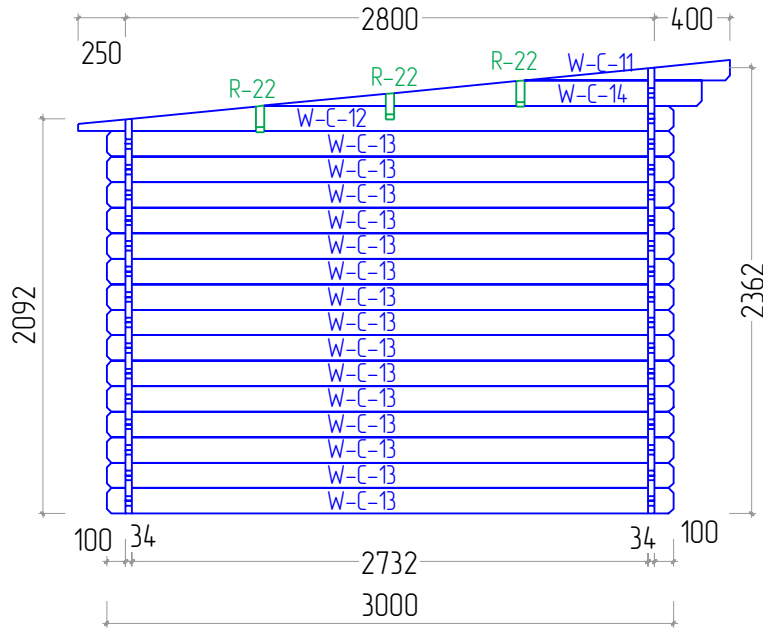

STAGE 3

Lillian 34 4X3 TP

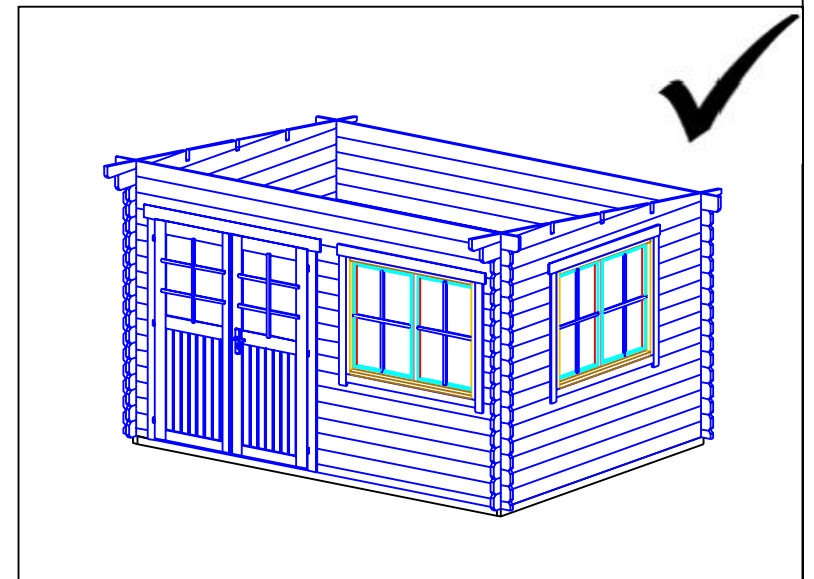
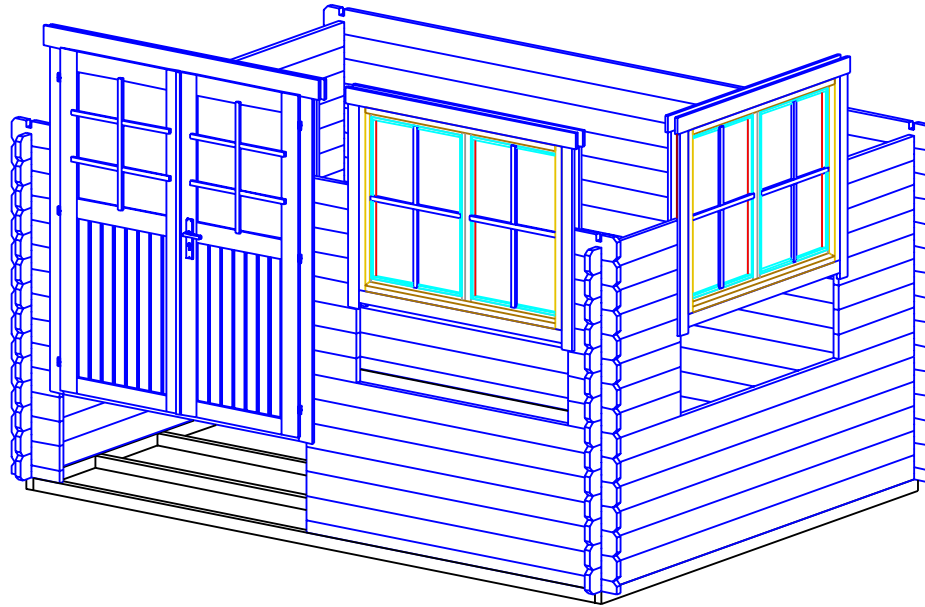

STAGE 4

Lillian 34 4X3 TP

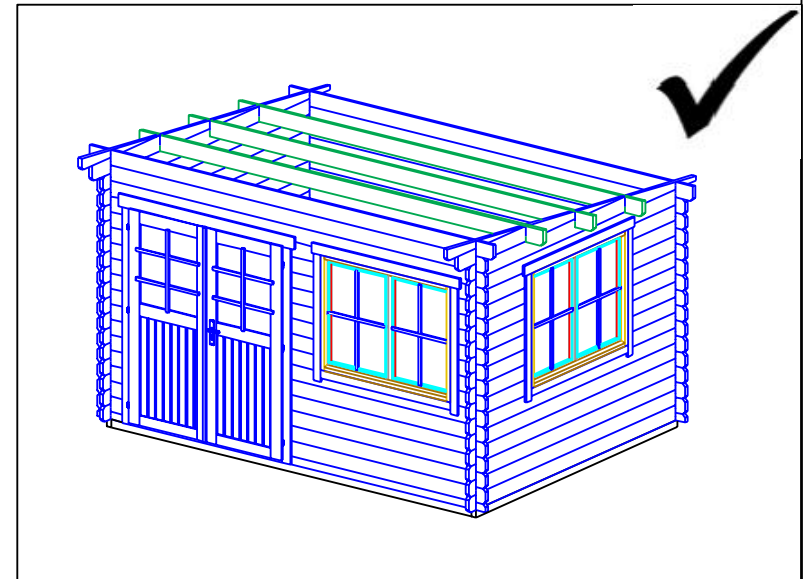
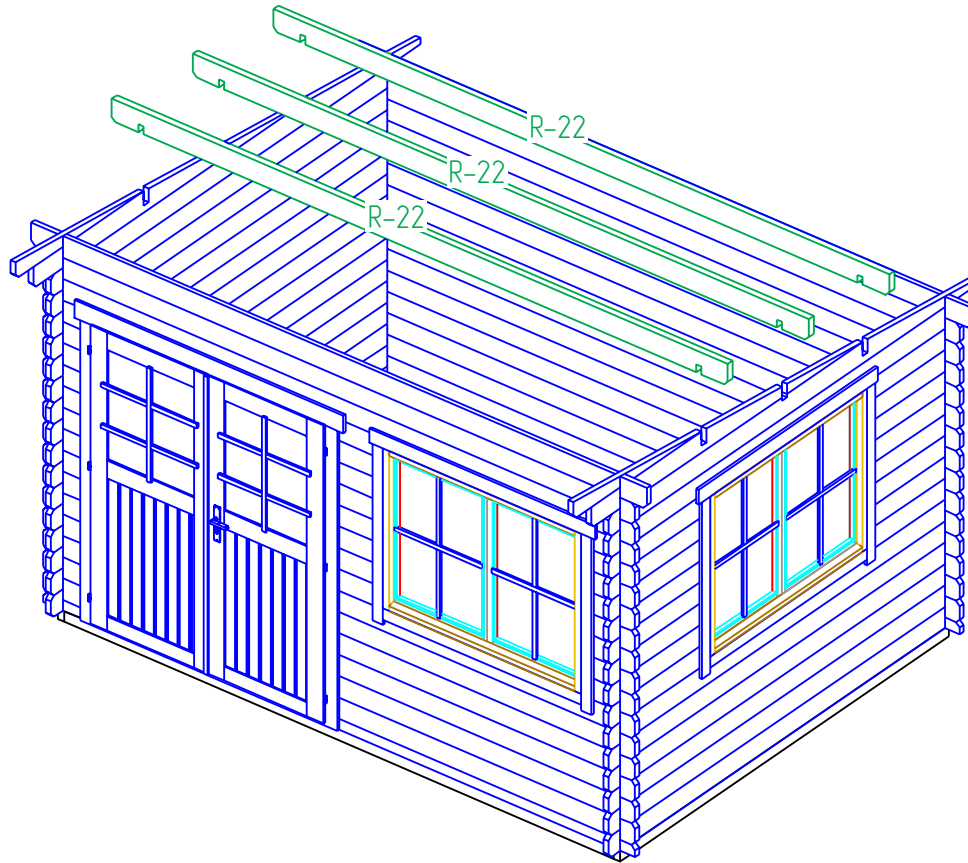



STAGE 5

Lillian 34 4X3 TP

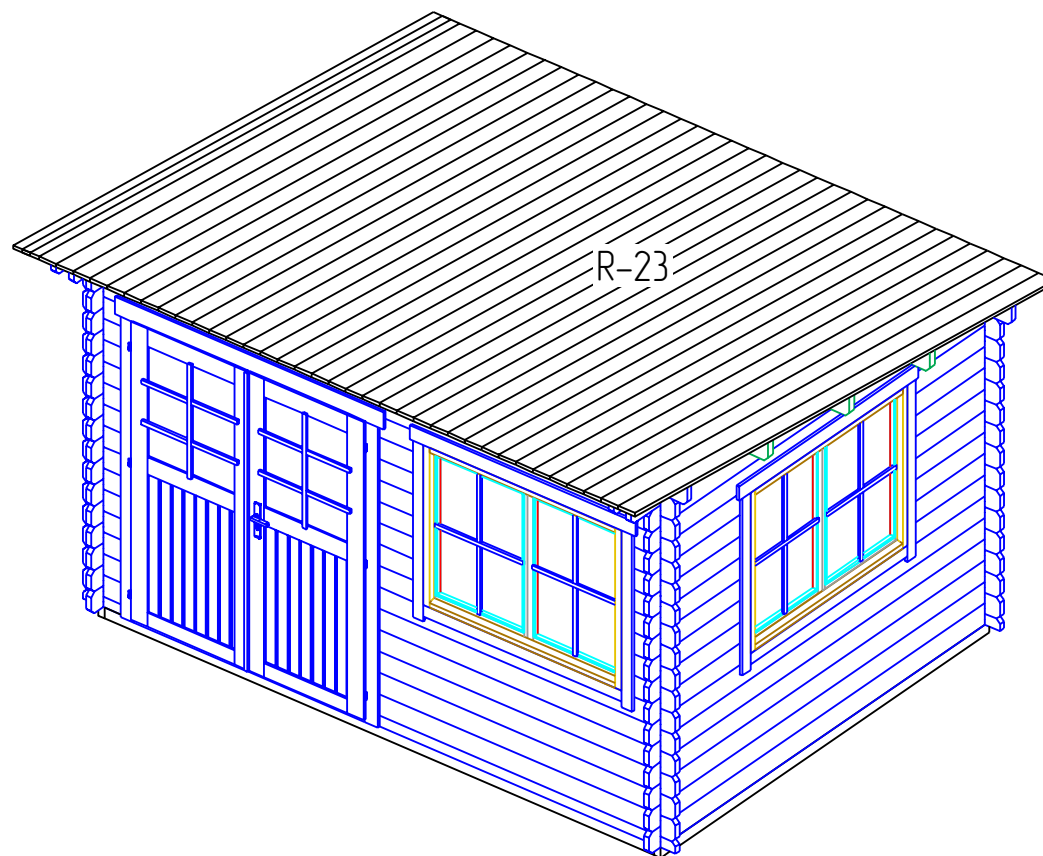

STAGE 6

Lillian 34 4X3 TP

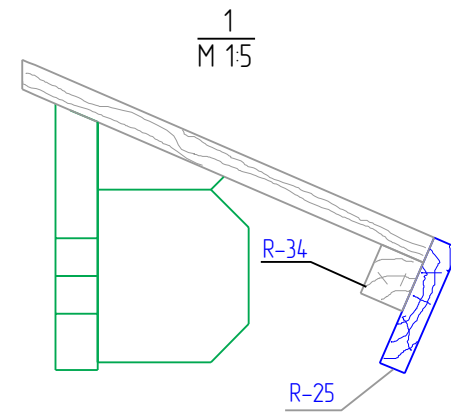
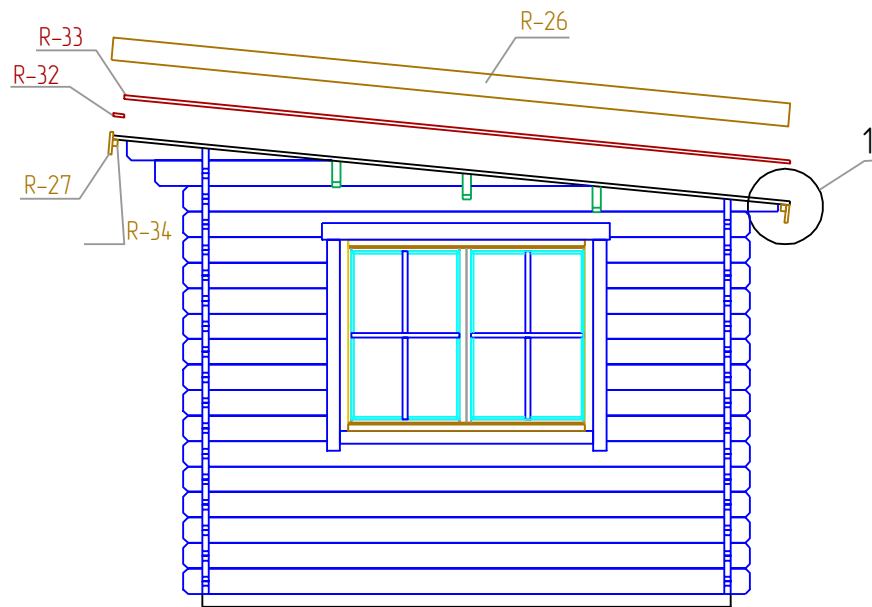

STAGE 6

Lillian 34 4X3 TP

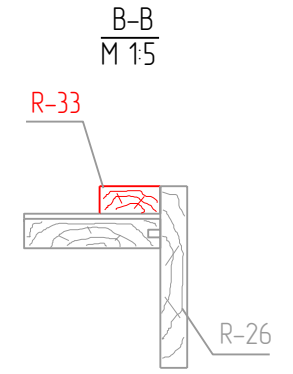
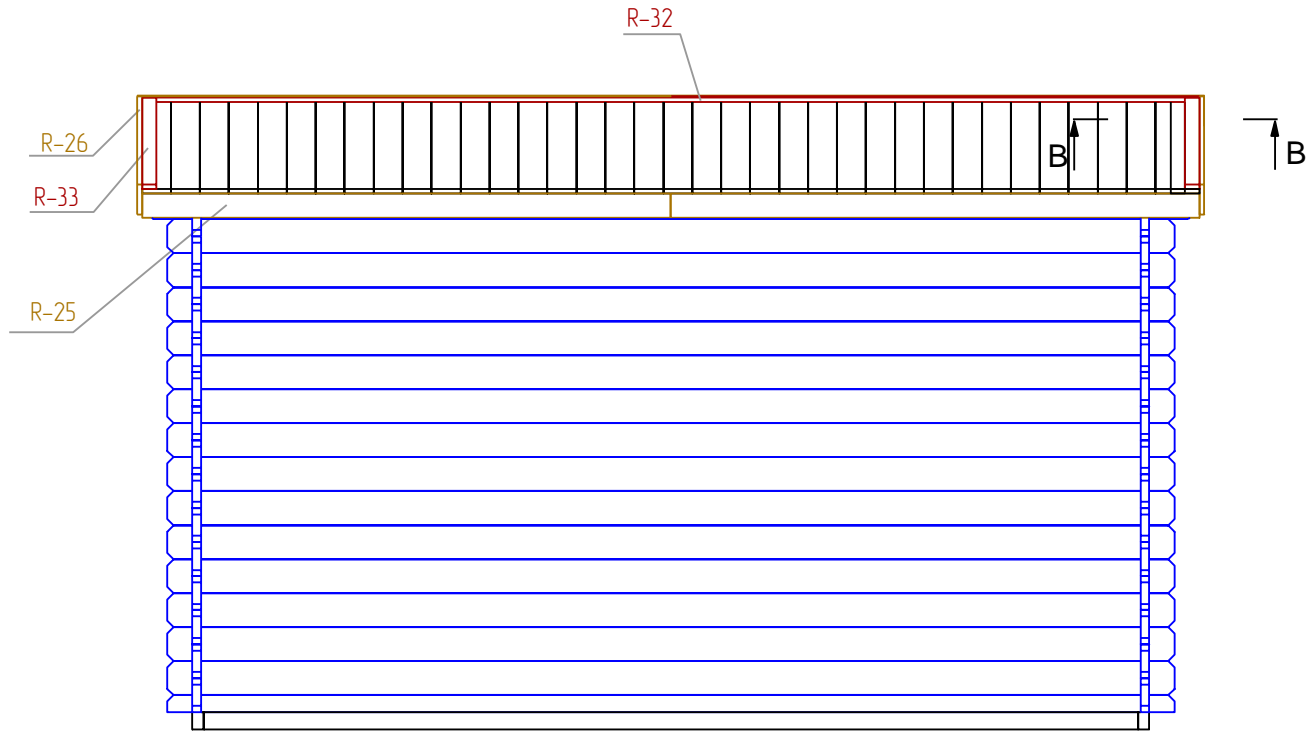

STAGE 7

Lillian 34 4X3 TP

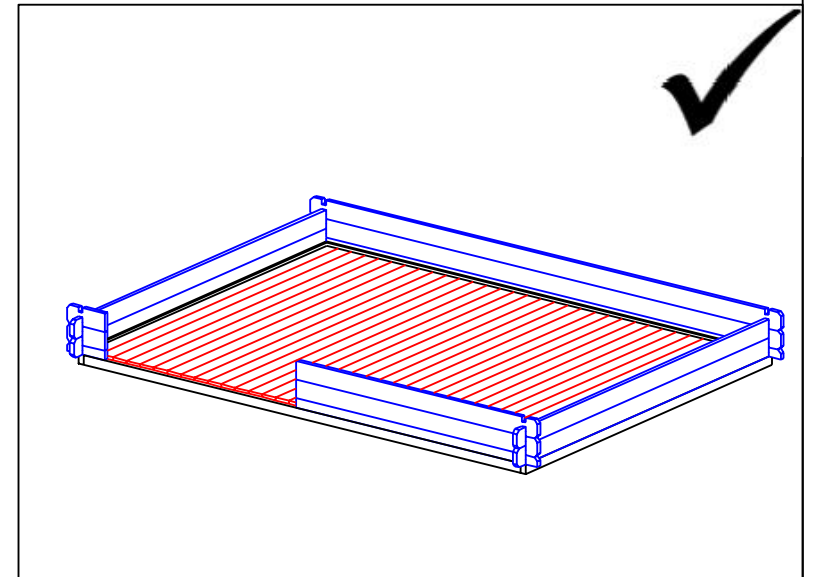
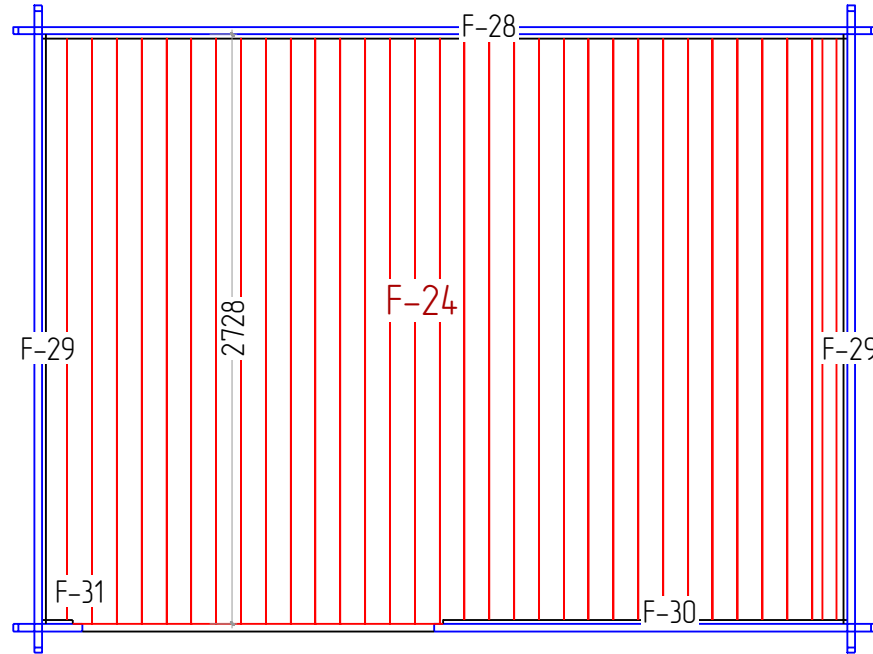

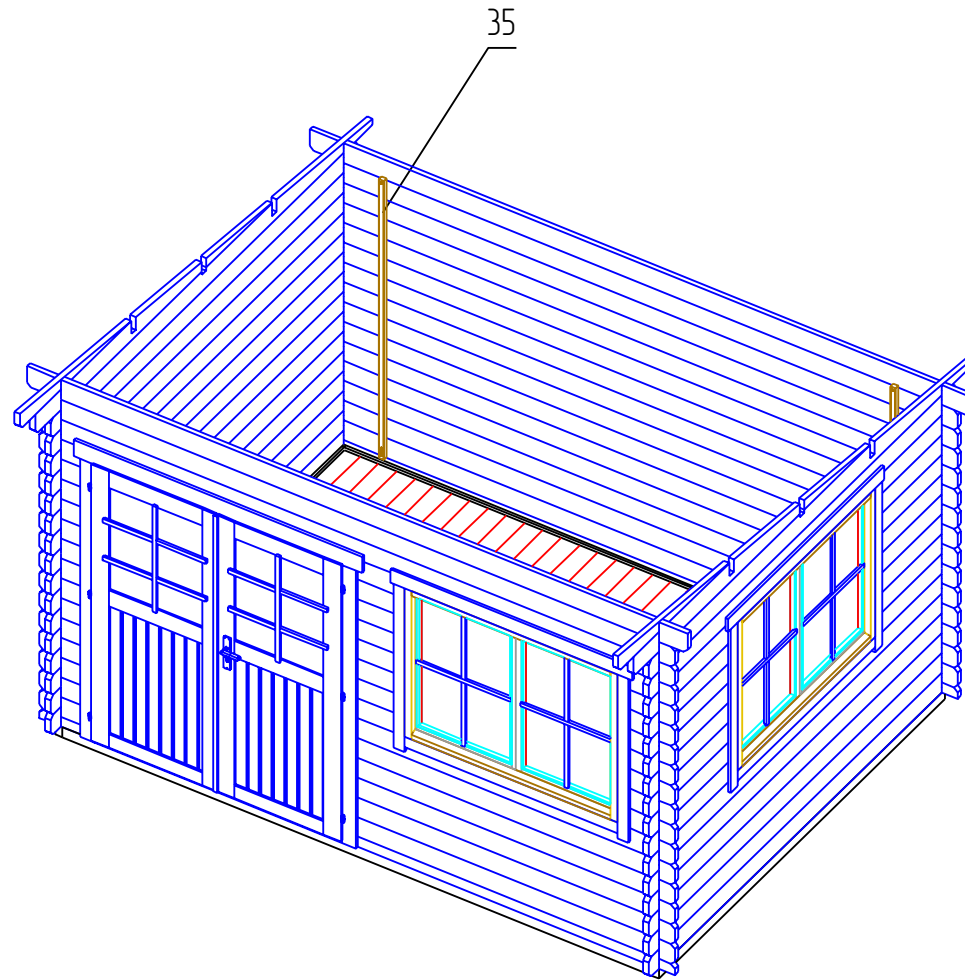

STAGE 1

F  
NR: 20  
PSC: 6  
B/H: 44mm/68mm  
L: 3712mm



F  
NR: 21  
PSC: 2  
B/H: 44mm/68mm  
L: 2800mm

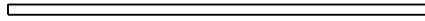

STAGE 2

W  
NR: A 1  
PSC: 1  
B/H: 34mm/68mm  
L: 2050mm



W  
NR: A 2  
PSC: 1  
B/H: 34mm/68mm  
L: 320mm

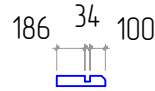

W  
NR: A 3  
PSC: 1  
B/H: 34mm/135mm  
L: 4160mm

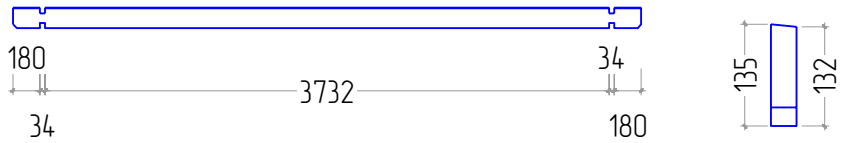

W  
NR: A 4  
PSC: 2  
B/H: 34mm/135mm  
L: 4000mm

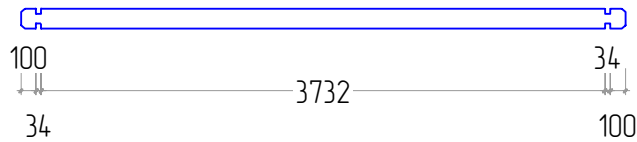

W  
NR: A 5  
PSC: 6  
B/H: 34mm/135mm  
L: 2050mm

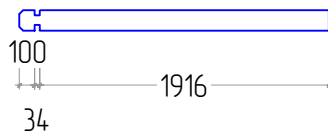

W  
NR: A 6  
PSC: 8  
B/H: 34mm/135mm  
L: 330mm



W  
NR: A 7  
PSC: 22  
B/H: 34mm/135mm  
L: 320mm

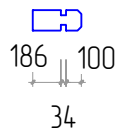

W  
NR: B 8  
PSC: 1  
B/H: 34mm/68mm  
L: 4000mm

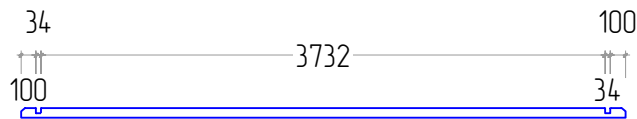

Lillian 34 4X3 TP

|   |  |
|---|--|
| <p>W<br/>NR: B 9<br/>PSC: 1<br/>B/H: 34mm/135mm<br/>L: 4160mm</p>   |  |
| <p>W<br/>NR: B 10<br/>PSC: 15<br/>B/H: 34mm/135mm<br/>L: 4000mm</p> |  |
| <p>W<br/>NR: C 13<br/>PSC: 15<br/>B/H: 34mm/135mm<br/>L: 3000mm</p> |  |
| <p>W<br/>NR: D 17<br/>PSC: 7<br/>B/H: 34mm/135mm<br/>L: 3000mm</p>  |  |
| <p>W<br/>NR: D 19<br/>PSC: 16<br/>B/H: 34mm/135mm<br/>L: 800mm</p>  |  |
| <p>W<br/>NR: C<br/>PSC: 1</p>                                       |  |
| <p>W<br/>NR: D<br/>PSC: 1</p>                                       |  |
| <p>STAGE 3</p>  |  |
| <p>Door<br/>PSC: 1<br/>B/H: 1630mm/1958mm</p>                       |  |
| <p>Window<br/>PSC: 2<br/>B/H: 1400mm/1080mm</p>                     |  |
| <p>STAGE 4</p>  |  |
| <p>R<br/>NR: 22<br/>PSC: 3<br/>B/H: 44mm/140mm<br/>L: 4160mm</p>    |  |

## STAGE 5

R  
 NR: 23  
 PSC: 38  
 B/H: 20mm/115mm  
 L: 3600mm



## STAGE 6

R  
 NR: 25  
 PSC: 2  
 B/H: 18mm/95mm  
 L: 2100mm



R  
 NR: 26  
 PSC: 2  
 B/H: 18mm/120mm  
 L: 3600mm



R  
 NR: 27  
 PSC: 2  
 B/H: 18mm/120mm  
 L: 2118mm



R  
 NR: 32  
 PSC: 1  
 B/H: 18mm/58mm  
 L: 4200mm



R  
 NR: 33  
 PSC: 2  
 B/H: 18mm/58mm  
 L: 3542mm



R  
 NR: 34  
 PSC: 2  
 B/H: 28mm/34mm  
 L: 4200mm



## STAGE 7

F  
 NR: 24  
 PSC: 34  
 B/H: 20mm/115mm  
 L: 2728mm



F  
 NR: 28  
 PSC: 1  
 B/H: 18mm/20mm  
 L: 3732mm



F  
 NR: 29  
 PSC: 2  
 B/H: 18mm/20mm  
 L: 2732mm





W-C

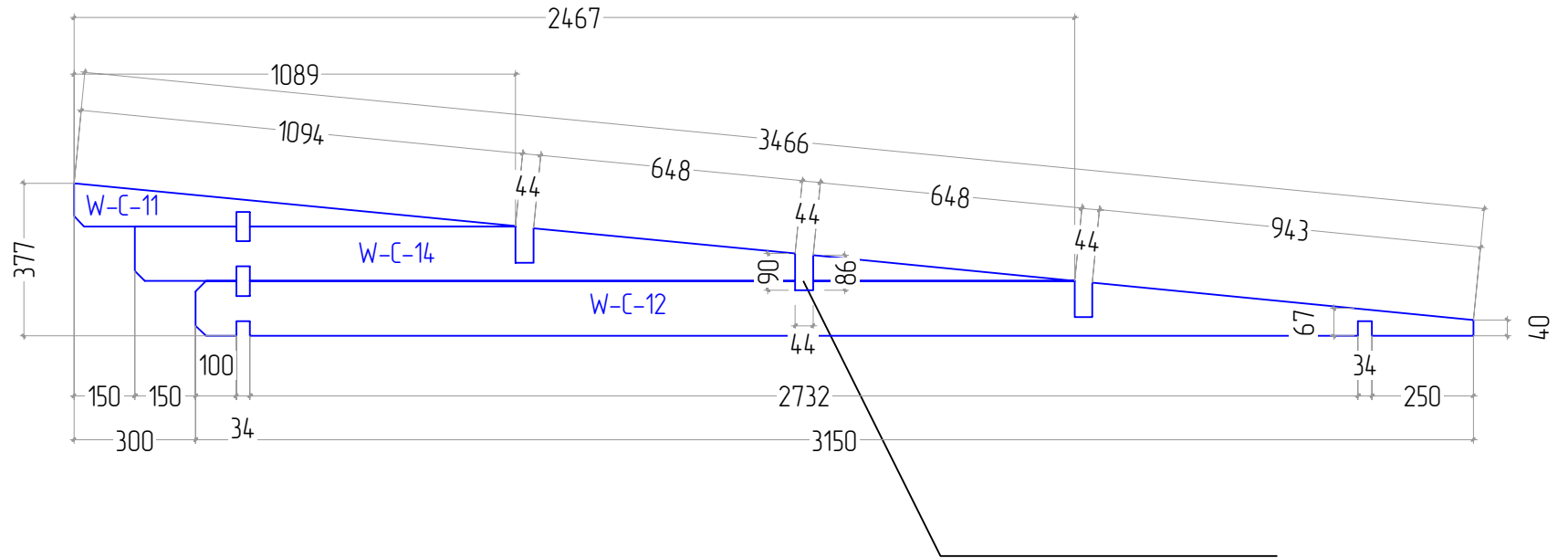

# W-D

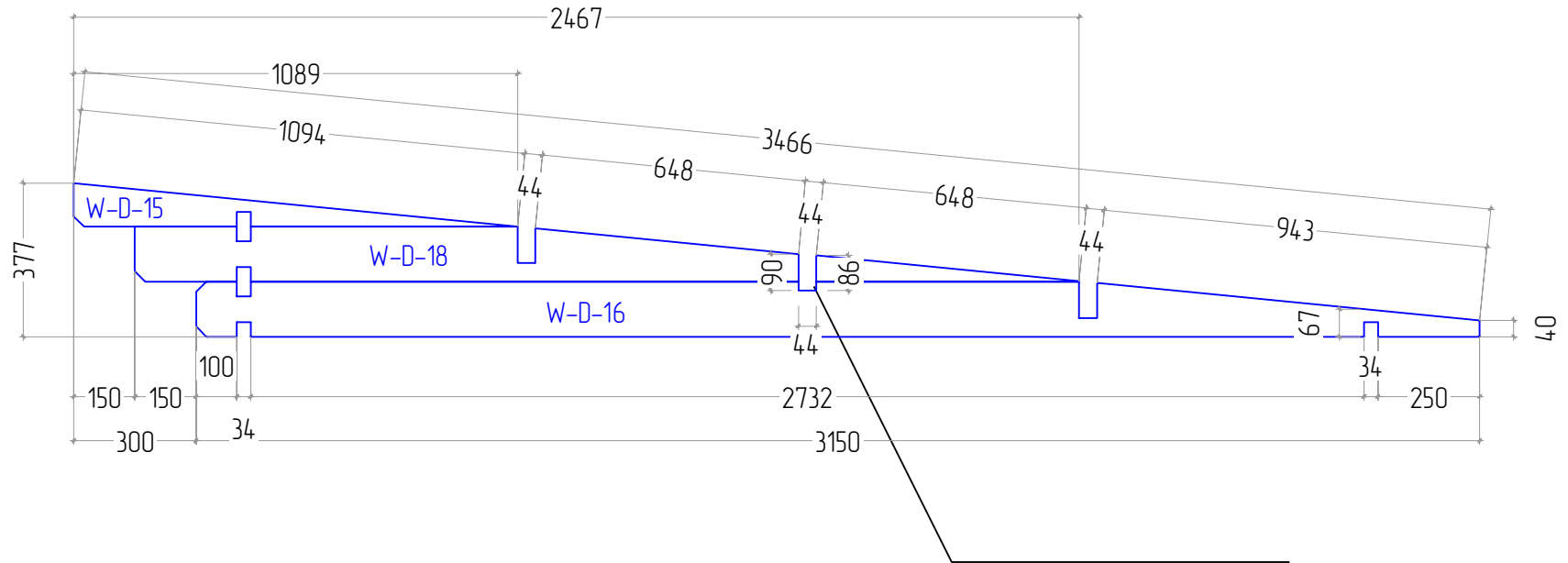

F  
NR: 30  
PSC: 1  
B/H: 18mm/20mm  
L: 1873mm

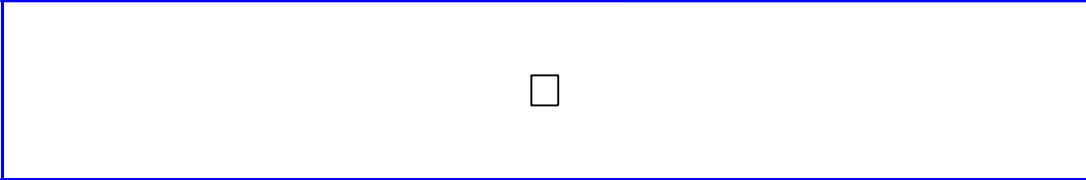

F  
NR: 31  
PSC: 1  
B/H: 18mm/20mm  
L: 143mm

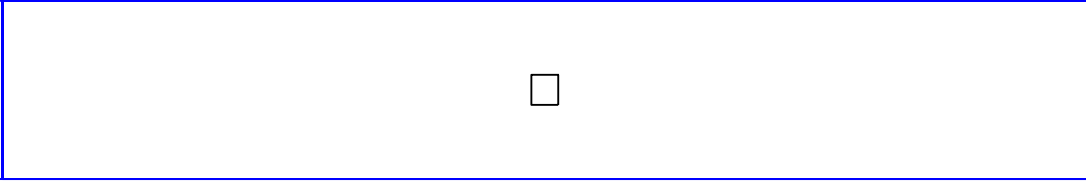

STAGE 8

NR: 35  
PSC: 4  
B/H: 28mm/34mm  
L: 1900mm

